

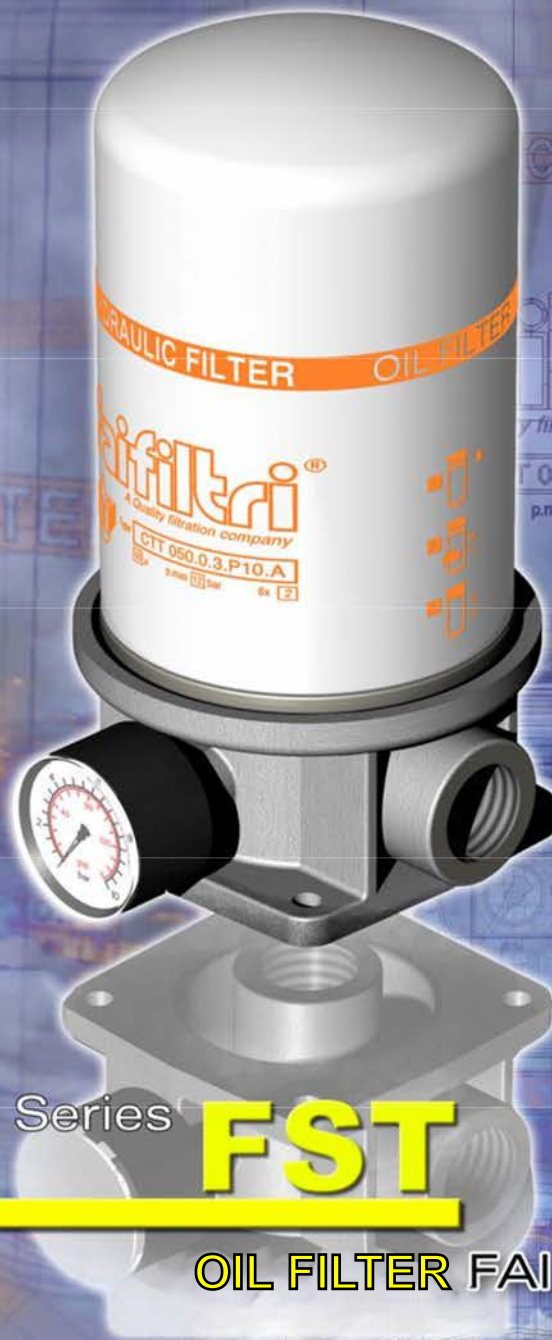

12 bar
170 psi



Series **FST**

OIL FILTER FAI FILTRI

DESCRIPTION

Many years of in-field experience have shown the necessity of more and more efficient controls on the contamination level of hydraulic fluids and fuels.

With this goal uppermost in its mind, and thanks to sophisticated design patterns and the use of cutting-edge materials and technologies, FAI FILTRI has engineered the **FST** series of complete filters, in different models and sizes, designed to meet a wide array of filtration and operating requirements, in order to allow a more effective control of contamination levels in hydraulic, lubricating, engine circuits, etc.

FST filters provide a valid solution to filtration problems granting their best performances when fitted into intake lines, hydraulic plants return and delivery lines and lubricating plants; they are particularly suitable for earthworks machineries, agricultural machines and generally speaking into any movable/ mobile machines with pressure peaks up to **12 bar**.

The fundamental characteristic of these elements is the possibility, for any clogged filter, to be easily replaced, by a quick and clean procedure, condition that has to be considered of great importance in working contexts where highly deteriorated environmental conditions usually occur.

They can support flow rates up to 300 l/min and each filter is equipped with an anti-emptying membrane and can have an optional by-pass valve.

Specifically, FAI FILTRI spin-on cartridges, equipped with new-generation "A" filtering media, can grant very high standards of performance even in the hardest conditions.

"A" type elements with absolute filtration power of 3, 6, 10, 25 micron ($\beta_x \geq 200$), are formed by inorganic impregnated and resin bonded inert micro-fibers, supported upstream and downstream. The result is a very compact filtering core which ensures the resistance of the media itself to deformation, distortion and strain, preventing any contaminants to get released, thus improving filtering performances and allowing contaminants to accumulate efficiently, also in the event of phenomena such as high differential pressure and water hammering derived from cold starts and discharge flow rates.

The above mentioned features make the FAI FILTRI spin-on filters consistent with the use of hydraulic, lubricating oils, fuels, glycol water, emulsions and most synthetic fluids

TECHNICAL DATA

MATERIALS

- ❑ Galvanized stamped plate flange
- ❑ Sinned and painted sheet steel vessel
- ❑ Perforated/drilled supporting pipes and galvanized steel end-caps
- ❑ Aluminum casted head

CARTRIDGE PRESSURE VALUES

Operative pressure:	12 bar
Impulse test in compliance with ISO 3724:	from 0-12-0 bar 1Hz 50.000 cycles min.

TESTS CARRIED OUT ON FILTERING ELEMENTS

Filtering elements differential collapsing pressure tested in compliance with ISO 2941:

"P" Type	5 bar
"A" and "M" Types	10 bar

Resistance to axial deformation tested in compliance with ISO 3723

Manufacturing conformity and determination/assessment of the first bubble point in compliance with ISO 2942

FILTERING ELEMENTS

- “P” 10 and 25 nominal micron made of $\beta_x > 2$ impregnated cellulose fibers
- “A” 3, 6, 10, 16 and 25 absolute micron made of $\beta_x \geq 200$ reinforced, inorganic fibers with polyester protections
- “M” 60 and 90 nominal micron made of wire net

New generation “A” filtering elements structure

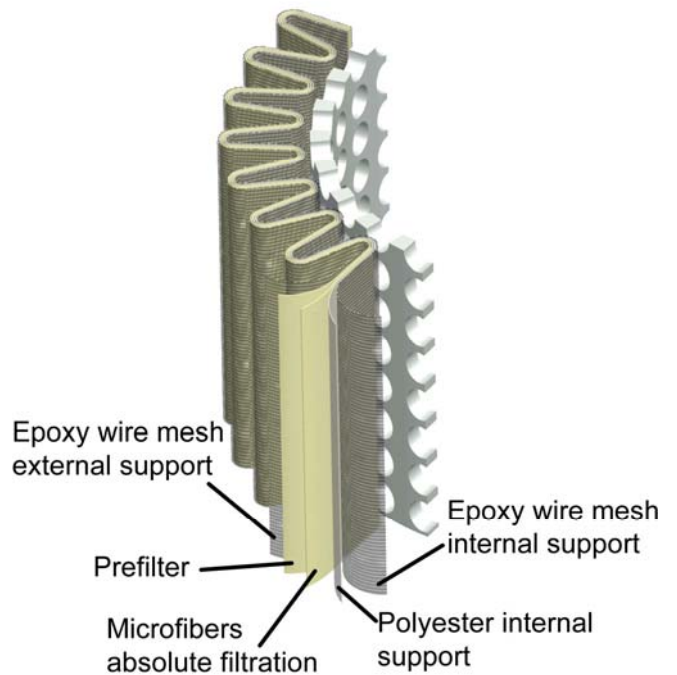

RETENTION POWER

In compliance with ISO 4572 Multi-pass test method

Filter element	Dimensions for β (μm) Value				Filtration rapport			Final ΔP (bar)
	$\beta \geq 2$ 50%	$\beta \geq 20$ 95%	$\beta \geq 75$ 98,7%	$\beta \geq 200$ 99,5%	β_2	β_{10}	β_{20}	
A03	-	2	2.4	3	20	>10000	>10000	7
A06	-	3	4.6	6	8	>2000	>10000	7
A10	3	6	7.8	10	1.5	≥ 200	>1000	7
A16	7	9	12	16	-	>25	>5000	7
A25	13	19	22	25	-	>1.5	>35	7
P10	10	>30	>30	-	1	2	4.5	4
P25	25	>30	>30	-	1	1	1.3	4

INTERNATIONAL STANDARDS FOR FLUIDS CONTAMINATION CONTROL

ISO 4406 CONTAMINATION CODES		NAS 1638 CORRESPONDING CLASS	SUGGESTED FILTRATION	APPLICATION FIELDS
5 μm	15 μm		$\beta_x \geq 200$	
12	9	3	1-2	High accuracy servo-plants – laboratory
15	11	6	3-6	Servo-plants – robotics – aeronautics
16	13	7	10-12	High sensitivity plants – where high standards of operating reliability are required
18	14	9	12-15	
19	16	10	15-25	General plant engineering with limited reliability
21	18	12	25-40	Low pressure plants – desultory services

BY-PASS VALVE

Assembled straight on the SPIN-ON cartridge with an opening differential pressure of 2 bar \pm 10%
Other values under request (custom-made)

GASKETS

Buna-N "A" type gaskets
Viton "V" type gaskets

COUPLINGS

"G" Series GAS Thread
"X" Series Specifically under request (custom-made)

OPERATING TEMPERATURE

From -25°C up to $+110^{\circ}\text{C}$ [For different temperatures please contact our technical department]

FLOW RATE

Up to 200 l/min
Choose the cartridge according to the filtration and to the recommended pressure drop.

INDICATORS

VR Type	:	Pressure gauge with 0÷10 bar scale	
L1 Type	:	Manostat with 1,5 bar gauging: (Exchanging contactcs)	Max operating tension: 250V Max current: 6 resistive/1 inductive Protection index: IP65

PRESSURE DROP

Curves are calculate in compliance with ISO 3968 and are applicable to clean filtering elements.

ΔP changes along with the density in presence of an eddy flow, and along with the dynamic viscosity in presence of a laminar flux. Curves are valid for mineral oils with a density of $0,86 \text{ Kg/dm}^3$ and a dynamic viscosity of $30 \text{ mm}^2/\text{sec}$ (cSt).

When choosing the filtering medium consider the pressure losses deriving from the flow rate:

Up to **0,3÷0,5 bar** for filters fitted on return line

(The total pressure loss is to be calculated by adding up the spin-on filter pressure drop. See CS-CTT catalogue)

FST50-70 - Ritorno

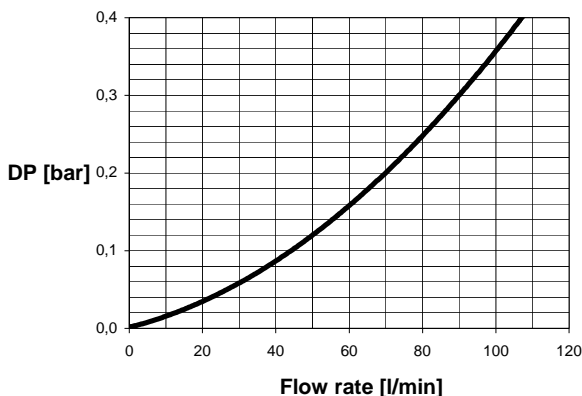

FCS100-150 - Ritorno

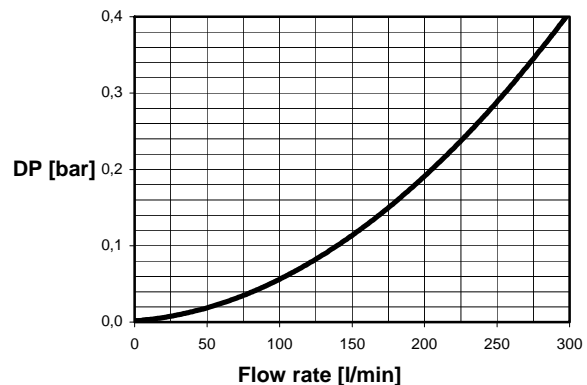

DIMENSIONAL INFORMATION

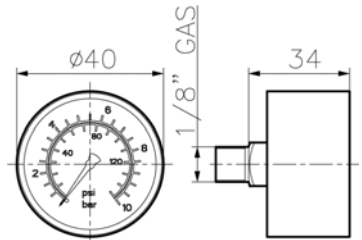
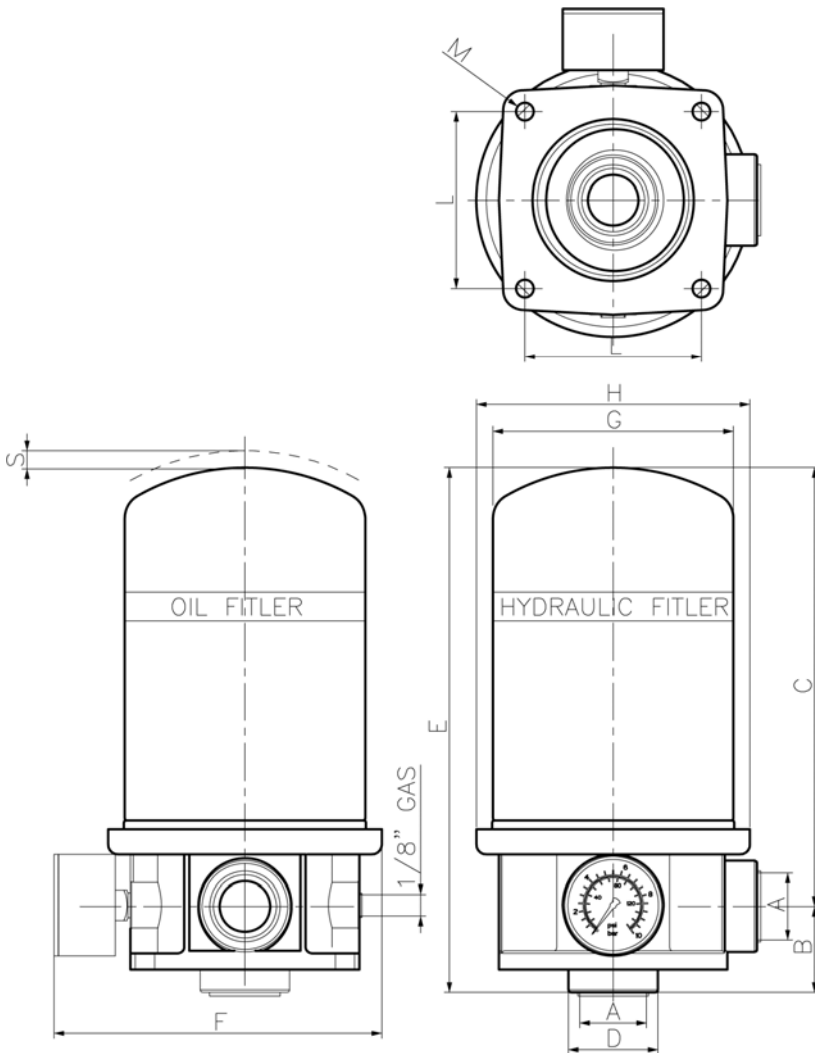

Return filter indicator
Scale: 0÷10 bar - VR Type

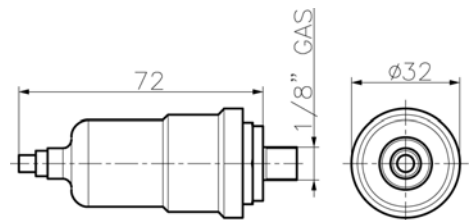

Manostat with exchanging contacts
Gauging: 1.5 bar - L1 type

Type	A	B	C	D	E	F	G	H	L	M	S
FST 050	3/4"	34	174	35	208	130	95	109	70	7	18
FST 070			200		234						
FST 100	1 1/2"	45	205	60	250	160	126	132	100	10	25
FST 150			235		280						

FUNCTIONAL DIAGRAM

Return lines

Filter element
FST050 N°1 CTT050.0
FST070 N°1 CTT070.0
FST100 N°1 CTT100.0
FST150 N°1 CTT150.0



ORDER CODE

